

VISTA 200

SOUNDBAR SYSTEM

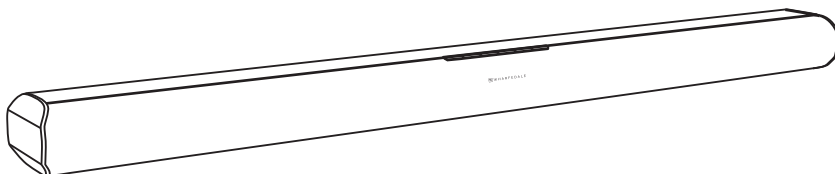

 W H A R F E D A L E

User Manual



USER INSTRUCTIONS: VISTA 200 SOUNDBAR SYSTEM

Important Safety Instructions



The lightning flash with arrowhead symbol, within an equilateral triangle, is intended to alert the user to the presence of uninsulated "dangerous voltage" within the product's enclosure that may be of sufficient magnitude as to constitute a risk of electric shock to persons.



The exclamation point within an equilateral triangle is intended to alert the user to the presence of important operating and maintenance (servicing) instructions in the literature accompanying the appliance.

Safety

- Read these instructions** - All the safety and operating instructions should be read before this product is operated.
- Keep these instructions** - The safety and operating instructions should be retained for future reference.
- Heed all warnings** - All warnings on the appliance and in the operating instructions should be adhered to.
- Follow all instructions** - All operations should follow instruction guidelines.
- Do not use this product near water** - The appliance should not be used near water or moisture - for example, in a wet basement or near a swimming pool and the like.
- Clean only with a dry cloth.
- Do not block any ventilation openings. Install in accordance with the manufacturer's instructions.
- Do not install near any heat sources such as radiators, heaters, stoves, or other apparatus (including amplifiers) that produce heat.
- Do not defeat the safety purpose of the polarized or grounding plug. A polarized plug has two blades with one wider than the other. A grounding plug has two blades and a third grounding prong. The wide blade or the third prong is provided for your safety. If the provided plug does not fit into your outlet, consult an electrician for replacement of the obsolete outlet.
- Protect the power cord from being walked on or pinched. The areas most commonly affected are situated where the power cord exits the plug and product.

**CAUTION**

**RISK OF ELECTRIC SHOCK
DO NOT OPEN**



CAUTION: TO REDUCE THE RISK OF ELECTRIC SHOCK, DO NOT REMOVE COVER (OR BACK). NO USER-SERVICEABLE PARTS INSIDE. REFER SERVICING TO QUALIFIED SERVICE PERSONNEL.

- Only use attachments/accessories specified by the manufacturer.
-  Use only with the cart, stand, tripod, bracket or table specified by the manufacturer, or sold with the product. When a cart or rack is used, use caution when moving the cart/apparatus combination to avoid injury from tip-over.
- Unplug the product during lightning storms or when unused for long periods of time.
- Refer all servicing to qualified personnel. Servicing is required when the apparatus has been damaged in any way, such as power supply cord or plug is damaged, liquid has been spilled or objects have fallen into the product, the unit has been exposed to rain or moisture, does not operate normally, or has been dropped.
- This equipment is a Class II or double insulated electrical appliance. It has been designed in such a way that it does not require a safety connection to electrical earth.
- The product shall not be exposed to dripping or splashing. No objects filled with liquids, such as vases, shall be placed on the product.
- Minimum distance around the product for sufficient ventilation is 5cm.
- The ventilation should not be impeded by covering the ventilation openings with items, such as newspapers, table-cloths, curtains, etc...
- No naked flame sources, such as lighted candles, should be placed on the product.
- Batteries should be recycled or disposed of as per state and local guidelines.
- The use of product in moderate climates.

Caution

- Use of controls or adjustments or performance of procedures other than those described herein, may result in hazardous radiation exposure or other unsafe operation.
- To reduce the risk of fire or electric shock, do not expose this product to rain or moisture. The product must not be exposed to dripping or splashing and objects filled liquids, such as vases, must not be placed on with product.
- The mains plug/appliance coupler is used as the disconnect device, the disconnect device must remain readily operable.
- Danger of explosion if battery is incorrectly replaced.
- Replace only with the same or equivalent type.

Warning

- The battery (batteries or battery pack) shall not be exposed to excessive heat such as sunshine, fire.
- Before operating this system, check the voltage of this system to see if it is identical to the voltage of your local power supply.
- Do not place this unit close to strong magnetic fields.
- Do not place this unit on the amplifier or receiver.
- Do not place this unit close to damp areas as the moisture will affect the life of the laser head.
- If any solid object or liquid falls into the system, unplug the system and have it checked by qualified personnel before operating it any further.
- Do not attempt to clean the unit with chemical solvents as this may damage the finish. Use a clean, dry or slightly damp cloth.
- When removing the power plug from the wall outlet, always pull directly on the plug, never yank on the cord.
- Changes or modifications to this unit not expressly approved by the party responsible for compliance will void the user's authority to operate the equipment.
- The rating label is pasted on the bottom or back of the equipment.

DO NOT INGEST BATTERY, CHEMICAL BURN HAZARD

The remote control supplied with this product contains a coin/button cell battery. If the coin/button cell battery is swallowed, it can cause severe internal burns in just 2 hours and lead to death. Keep new and used batteries away from children. If the battery compartment does not close securely, stop using the product and keep it away from children. If you think batteries might have been swallowed or placed inside any part of the body, seek immediate medical attention.



Correct Disposal of this product. This marking indicates that this product should not be disposed with other household wastes throughout the EU. To prevent possible harm to the environment or human health from uncontrolled waste disposal, recycle it responsibly to promote the sustainable reuse of material resources. To return your used device, please use the return and collection systems or contact the retailer where the product was purchased. They can take this product for environmental safe recycling.



We hereby declares that this product is in compliance with the essential requirements and other relevant provisions of Directive 2014/53/ EU.



The Bluetooth word mark and logos are registered trademarks owned by Bluetooth SIG, Inc.



The terms HDMI and HDMI High-Definition Multimedia Interface, and the HDMI Logo are trademarks or registered trademarks of HDMI Licensing, LLC in the United States and other countries.

USER INSTRUCTIONS: VISTA 200 SOUND BAR SYSTEM

What's in the Box

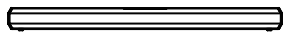

Main Unit

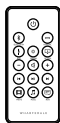

Remote Control

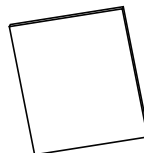

User Manual



AC Power Cable



3.5mm to 3.5mm audio Cable



RCA to 3.5mm audio Cable



Wall Bracket

- Design and specifications are subject to change without notice.

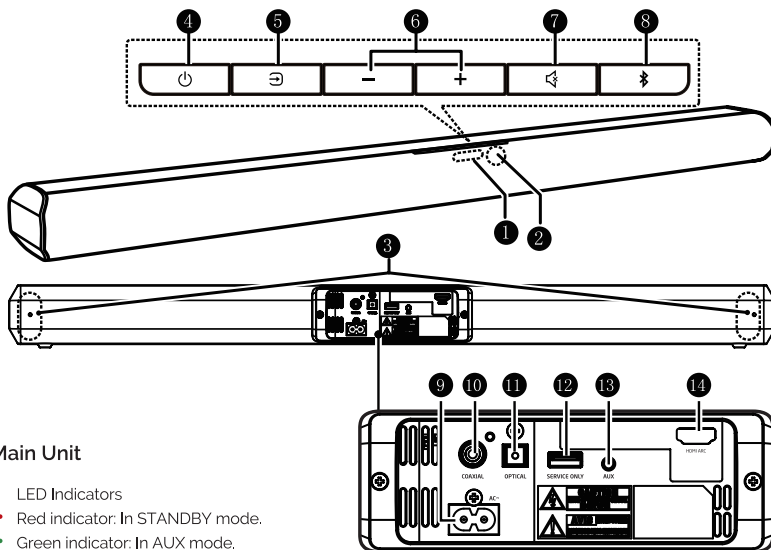

Main Unit

1. LED Indicators

- Red indicator: In STANDBY mode.
- Green indicator: In AUX mode.
- Blue indicator: In Bluetooth mode.
- Orange indicator: In OPTICAL mode.
- Orange indicator after 3" flash: In Coaxial mode.
- White indicator: In HDMI ARC mode.

2. Remote Control Sensor

3. Wall bracket screws

4. Power button

Switch the unit between ON and STANDBY mode.

5. Play/Pause button

Select the play function.

6. + / - buttons

Increase/decrease the volume level.

7. Mute button

Mute or resume the sound.

8. Bluetooth button

Select the Bluetooth mode.

Press and hold to activate the pairing function in Bluetooth mode or disconnect the existing paired Bluetooth device.

9. AC~ Socket

Connect power cord.

10. COAXIAL Socket

11. OPTICAL Socket

12. SERVICE ONLY Socket

The USB socket is for service only.

13. AUX Socket





Connect to an external audio device.

14. HDMI ARC Socket

Connect to a TV via HDMI cable.

USER INSTRUCTIONS: VISTA 200 SOUNDBAR SYSTEM

Remote Control

1.  Switch the unit between ON and STANDBY mode.
2. **Function buttons** Select the play function.
Press and hold the  button to activate the pairing function in Bluetooth mode or disconnect the existing paired Bluetooth device.
3.  Skip to previous/next track in Bluetooth mode.
 Play/pause/resume playback in Bluetooth mode.
4.  **(MUTE)** Mute or resume the sound.
+/- (Volume) Increase/decrease the volume level.
5. **MOVIE/MUSIC/NEWS** Select equaliser (EQ) effect.

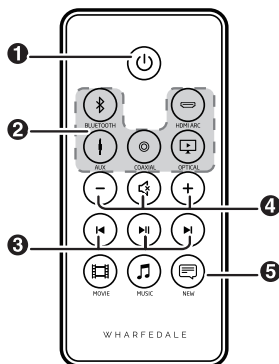

Prepare the Remote Control

The provided Remote Control allows the unit to be operated from a distance.

- Even if the Remote Control is operated within the effective range 6m, remote control operation may be impossible if there are any obstacles between the unit and the remote control.
- If the Remote Control is operated near other products which generate infrared rays, or if other remote control devices using infra-red rays are used near the unit, it may operate incorrectly. Conversely, the other products may operate incorrectly.

First-time use:

The unit has a pre-installed lithium CR2025 battery.
Remove the protective tab to activate the remote control battery.

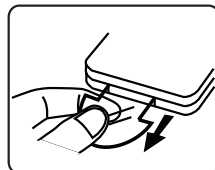

Replace the Remote Control Battery

- The remote control requires a CR2025, 3V Lithium battery.
1. Push the tab on the side of the battery tray towards the tray.
 2. Now slide the battery tray out of the remote control.
 3. Remove the old battery. Place a new CR2025 battery into the battery tray with the correct polarity (+/-) as indicated.
 4. Slide the battery tray back into the slot in the remote control.

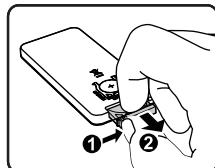

Precautions Concerning Batteries

- When the Remote Control is not to be used for a long time (more than a month), remove the battery from the Remote Control to prevent it from leaking.
- If the batteries leak, wipe away the leakage inside the battery compartment and replace the batteries with new ones.
- Do not use any batteries other than those specified.
- Do not heat or disassemble batteries.
- Never throw them in fire or water.
- Do not carry or store batteries with other metallic objects. Doing so could cause batteries to short circuit, leak or explode.
- Never recharge a battery unless it is confirmed to be a rechargeable type.

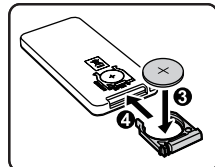

Placement and Installation

Placement

- If your TV is placed on a table, you can place the unit on the table directly in front of the TV stand, centered with the TV screen.
- If your TV is attached to a wall, you can mount the unit on the wall directly below the TV screen.

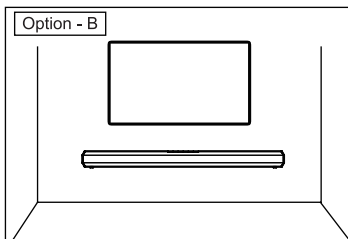
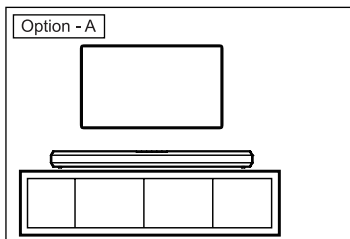

Wall Mounting (if using option-B)

Note

- Installation must be carried out by qualified personnel only. Incorrect assembly can result in severe personal injury and property damage (if you intend to install this product yourself, you must check for installations such as electrical wiring and plumbing that may be buried inside the wall). It is the installer's responsibility to verify that the wall will safely support the total load of the unit and wall brackets.
- Additional tools (not included) are required for the installation.
- Do not overtighten screws.
- Keep this instruction manual for future reference.
- Use an electronic stud finder to check the wall type before drilling and mounting.

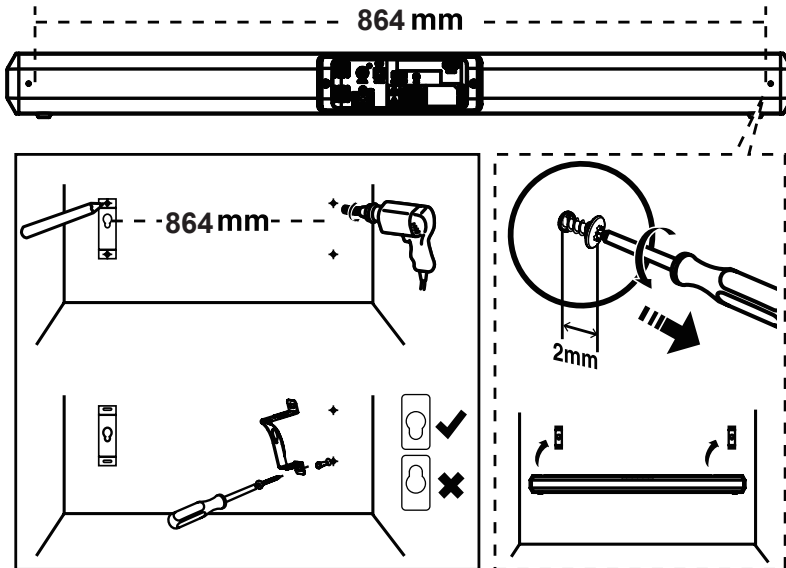

Use the HDMI (ARC) Socket

ARC (Audio Return Channel)

The ARC (Audio Return Channel) function allows you to send audio from your ARC-compliant TV to your sound bar through a single HDMI connection. To enjoy the ARC function, please ensure your TV is both HDMI-CEC and ARC compliant and set up accordingly. When correctly set up, you can use your TV remote control to adjust the volume output (VOL +/- and MUTE) of the sound bar.

- Connect the HDMI cable (not included) from unit's **HDMI (ARC)** socket to the HDMI (ARC) socket on your ARC compliant TV. Then press the remote control to select **HDMI ARC** mode.

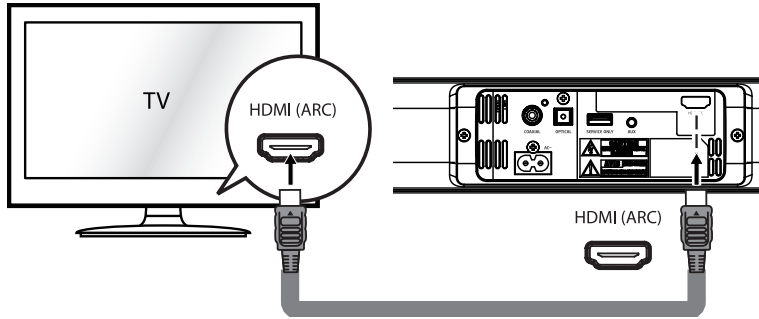

Tips:

- Your TV must support the HDMI-CEC and ARC function. HDMI-CEC and ARC must be set to On.
- The setting method of HDMI-CEC and ARC may differ depending on the TV. For details about ARC function, please refer to your TV owner's manual.
- Only HDMI 1.4 cables can support the ARC function.

Use the COAXIAL Socket

- You also can use the COAXIAL cable (not included) to connect the TV's COAXIAL OUT socket and COAXIAL socket on the unit.

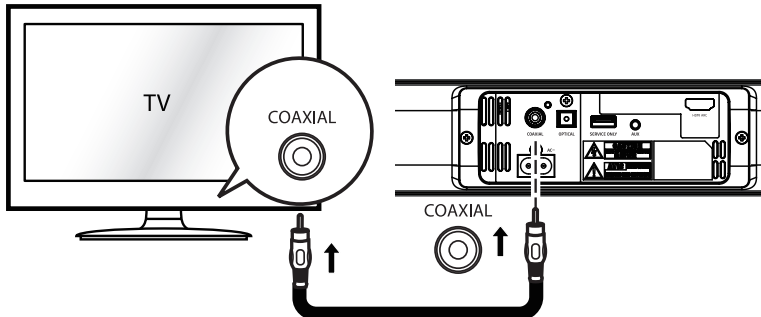

Use the OPTICAL Socket

- Remove the protective cap of the **OPTICAL** socket, then connect an **OPTICAL** cable (not included) to the TV's **OPTICAL OUT** socket and the **OPTICAL** socket on the unit.

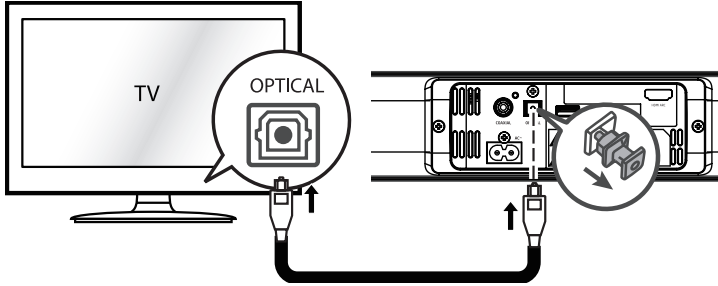

Use the AUX Socket

- A. Use a RCA to 3.5mm audio cable (included) to connect the TV's audio output sockets to the **AUX** socket on the unit.

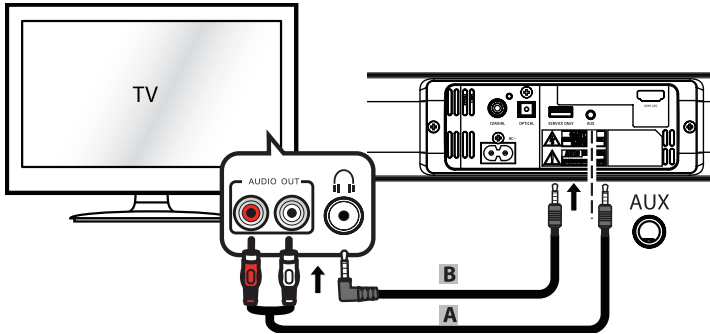

- B. Use a 3.5mm to 3.5mm audio cable (included) to connect the TV's or external audio device headphone socket to the **AUX** socket on the unit.

Connect to Power

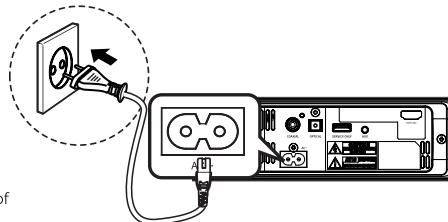

- Before connecting the **AC** power cord, ensure you have all other connections completed
- Risk of product damage! Ensure that the power supply voltage corresponds to the voltage printed on the back or the underside of the unit.
- Connect the mains cable to the **AC**- Socket of the unit and then into a mains socket









 USER INSTRUCTIONS: VISTA 200 SOUND BAR SYSTEM

Standby/ON



When you first connect the main unit to the mains socket, the main unit will be in Standby mode.

- Press the  button on the unit or on the remote control to switch the unit ON.
- Press the  button again on the remote control or on the unit to switch the unit back to STANDBY mode. The POWER indicator will light up red.
- Disconnect the mains plug from the mains socket if you want to switch the unit OFF completely.
- If a TV or an external device (Only for **AUX** socket) is connected, the main unit and the subwoofer will switch on automatically when the TV or the external device is switched on.
- When the unit no input signal (or weak input signal) for over 15 minutes, the unit will automatically switch to Standby mode.



Select Modes





- Press the  button repeatedly on the unit or press the  (**AUX**)  (**COAXIAL**),  (**OPTICAL**),  (**HDMI ARC**),  (**BLUETOOTH**) buttons on the remote control to select the desired mode.
- The indicator light on the front of the main unit will show which mode is currently in use.
 - Red indicator: In STANDBY mode.
 - Green indicator: In AUX mode.
 - Blue indicator: In Bluetooth mode.
 - Orange indicator: In OPTICAL mode.
 - Orange indicator after 3" flash: In Coaxial mode.
 - White indicator: In HDMI ARC mode.

Adjust the Volume

- Press the **VOL+** / **VOL-** buttons on the unit or on the remote control to adjust the volume. .
- While adjusting the volume,the status indicator flashes quickly.
- While the volume level reaches its maximum level, if you press the **VOL+** button again, the status indicator flashes once.While the volume level reaches its minimum level,if you press the **VOL-** button again,the status indicator flashes once.
- If you wish to turn the sound off, press the  (**MUTE**) button on the unit or on the remote control. Press the  (**MUTE**) button again or press the **VOL+** / **VOL-** buttons to resume normal listening.

Select Equaliser (EQ) Effect

- While playing, press the  **MOVIE** /  **MUSIC** /  **NEWS** buttons on the remote control to select preset equalisers: **MOVIE** (recommended for viewing movies), **MUSIC** (recommended for listening to music), **NEWS** (recommended for listening to news).

- Ensure that the unit is connected to the TV or audio device.
- 1. Press the  button repeatedly on the unit or press the  (AUX) ,  (COAXIAL) ,  (OPTICAL) ,  (HDMI ARC) buttons on the remote control to to select the desired mode.
- 2. Operate your audio device directly for playback features.
- 3. Press the **VOL +/-** buttons to adjust the volume to your desired level.



Tip:

- While in **OPTICAL / COAXIAL / HDMI ARC** mode, if there's no sound output from the unit and the **OPTICAL/COAXIAL/HDMI ARC** Indicator flashes, you may need to activate PCM signal output on your source device (eg. TV, DVD or Blu-ray player).

Connect to a Bluetooth Device

The first time you connect your Bluetooth device to this player, you need to pair your device to this player.

Note:

- The operational range between this player and a Bluetooth device is approximately 8 meters (without any object between the Bluetooth device and the unit).
 - Before you connect a Bluetooth device to this unit, ensure you know the device's capabilities.
 - Compatibility with all Bluetooth devices is not guaranteed.
 - Any obstacle between this unit and a Bluetooth device can reduce the operational range.
 - If the signal strength is weak, your Bluetooth receiver may disconnect, but it will re-enter pairing mode automatically.
1. During ON mode, press the  buttons on the remote control or the on the unit to select **Bluetooth** mode. The Blue indicator will flash slowly.
 2. Activate your Bluetooth device and select the search mode. "VISTA 200" will appear on your Bluetooth device list.
 - If you cannot find the soundbar, press and hold the  button on the unit or on the remote control. The system has entered pairing mode. The unit 'Blue' indicator will flash rapidly and prompt "Pairing".
 3. Select "VISTA 200" enter "0000" for the password if necessary. The unit will voice "Paired" and the Blue indicator will light up solidly.
 4. Play music from the connected Bluetooth device.



To disconnect the Bluetooth function, you can :

- Switch to another function on the unit.
- Disable the function from your Bluetooth device. The Bluetooth device will be disconnected from the unit after the "Disconnected" voice prompt.
- Press and hold the  button on the unit or on the remote control.

Tips:

- Enter "0000" for the password if necessary.
- If no other Bluetooth device pairs with this player within two minutes, the player will recover its previous connection.
- The player will also be disconnected when your device is moved beyond the operational range.
- If you want to reconnect your device to this player, place it within the operational range.
- If the device is moved beyond the operational range, when it is brought back, please check if the device is still connected to the player.
- If the connection is lost, follow the instructions above to pair your device to the player again.

Listen to Music from Bluetooth Device

- If the connected Bluetooth device supports Advanced Audio Distribution Profile (A2DP), you can listen to the music stored on the device through the player.
 - If the device also supports Audio Video Remote Control Profile (AVRCP), you can use the player's remote control to play music stored on the device.
1. Pair your device with the player.
 2. Play music via your device (if it supports A2DP).
 3. Use supplied remote control to control play (if it supports AVRCP).
 - To pause/resume play, press the  button on the remote control.
 - To skip to a track, press the  buttons on the remote control.

To keep the warranty valid, never try to repair the system yourself. If you encounter problems when using this unit, check the following points before requesting service.

No power

- Ensure that the AC cord of the apparatus is properly connected .
- Ensure that there is power at the AC outlet.
- Press standby button to turn the unit on.

Remote control does not work

- Before you press any playback control button, first select the correct source.
- Reduce the distance between the remote control and the unit.
- Insert the battery with its polarities (+/-) aligned as indicated.
- Replace the battery.
- Aim the remote control directly at the sensor on the front of the unit.

No sound

- Increase the volume. Press Volume Up on the remote control or on the right side of the soundbar.
- Press MUTE on the remote control to ensure the soundbar is not muted.
- Press source buttons to select a different input source.
- When using either of the Digital inputs, if there is no audio:
 - Try setting the TV output to PCM or
 - Connect directly to your Blu-ray/other source, some TVs do not pass through digital audio.
- Your TV may be set to variable audio output. Confirm that the audio output setting is set to FIXED or STANDARD, not VARIABLE. Consult your TV's user manual for more detailed information.
- If using Bluetooth, ensure that the volume on your source device is turned up and that the device is not muted.

I can't find the Bluetooth name of this unit on my Bluetooth device for Bluetooth pairing

- Ensure the Bluetooth function is activated on your Bluetooth device.
- Ensure you have paired the unit with your Bluetooth device.

This is a 15 mins power off function, one of the ERPII standard requirement for saving power

- When the unit's external input signal level is too low, the unit will be turned off automatically in 15 minutes. Please increase the volume level of your external device.

Specifications

Model	VISTA 200
Soundbar	
Power Supply	AC 100-240V~ 50/60Hz
Output Power	30 W x 2
Power Consumption	80 W / < 0,5 W (Standby)
Frequency Response	40Hz - 20KHz
Audio input sensitivity (AUX)	500mV
Speakers Impedance	8Ω x 2
Dimension (W x H x D)	900 x 62 x 92 mm
Bluetooth	
Version	V 4.2
Maximum power transmitted	<5 dbm
Frequency bands	2402 MHz ~ 2480 MHz
Remote Control	
Distance	6m
Angle	30°
Battery Type	CR2025



 WHARFEDALE

IAG House, 13/14 Glebe Road, Huntingdon, Cambridgeshire, PE29 7DL, UK
Tel: +44(0)1480 452561 Fax: +44(0)1480 413403 www.wharfedale.co.uk
IAG reserves the right to alter the design and specifications without notice, All rights reserved © IAG Group Ltd.
Wharfedale is a member of the International Audio Group.

